

Weitere Rotorbohrungen und Eisenlängen in mm auf Anfrage.
Non-standard rotor bores and stator core length available upon request.
request.

Autres alésages rotateurs et longueur fer en mm sur demande.

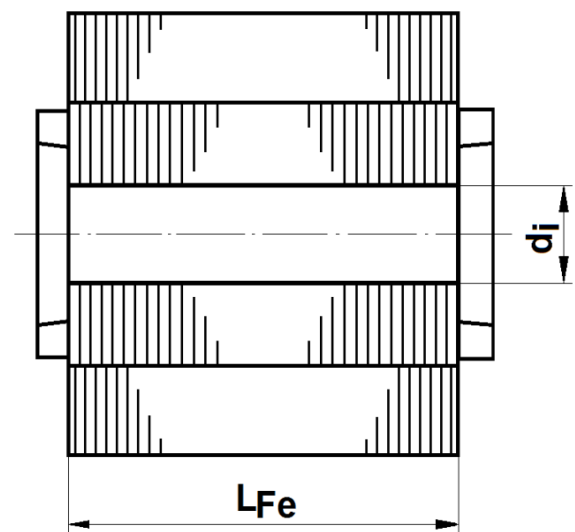
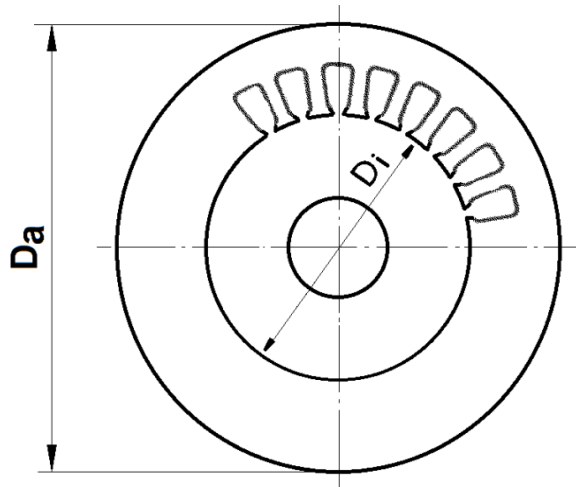

Baugröße Frame size Hauteur d'axe	kW	Abmessungen / Dimensions / Cotes						Artikel-Nr. / Item number / Numero d' article	
		L Fe	Da	Di	di	Nz Stator	Nz Rotor	Stator	Rotor
56	0,06	45	80	45	15	24	22	SSA056 4 0045 015	SRA056 4 0045 015
	0,09	55						SSA056 4 0055 015	SRA056 4 0055 015
63	0,12	45	90	50	18	24	22	SSA063 4 0045 018	SRA063 4 0045 018
	0,18	60						SSA063 4 0060 018	SRA063 4 0060 018
71	0,25	50	106,5	62	20	24	22	SSA071 4 0050 020	SRA071 4 0050 020
	0,37	65						SSA071 4 0065 020	SRA071 4 0065 020
80	0,55	60	120	70	25	24	22	SSA080 4 0060 025	SRA080 4 0060 025
	0,75	80						SSA080 4 0080 025	SRA080 4 0080 025
90S	1,1	75	135	80	30	36	28	SSA090 4 0075 030	SRA090 4 0075 030
90L	1,5	100						SSA090 4 0100 030	SRA090 4 0100 030
100L	2,2	90	150	90	36	36	28	SSA100 4 0090 036	SRA100 4 0090 036
	3	120						SSA100 4 0120 036	SRA100 4 0120 036
112M	4	140	170	103	38	36	28	SSA112 4 0140 038	SRA112 4 0140 038
132S	5,5	125	200	125	50	36	28	SSA132 4 0125 050	SRA132 4 0125 050
132M	7,5	170						SSA132 4 0170 050	SRA132 4 0170 050

Weitere Rotorbohrungen und Eisenlängen in mm auf Anfrage.
Non-standard rotor bores and stator core length available upon request.

Autres alésages rotateurs et longueur fer en mm sur demande.

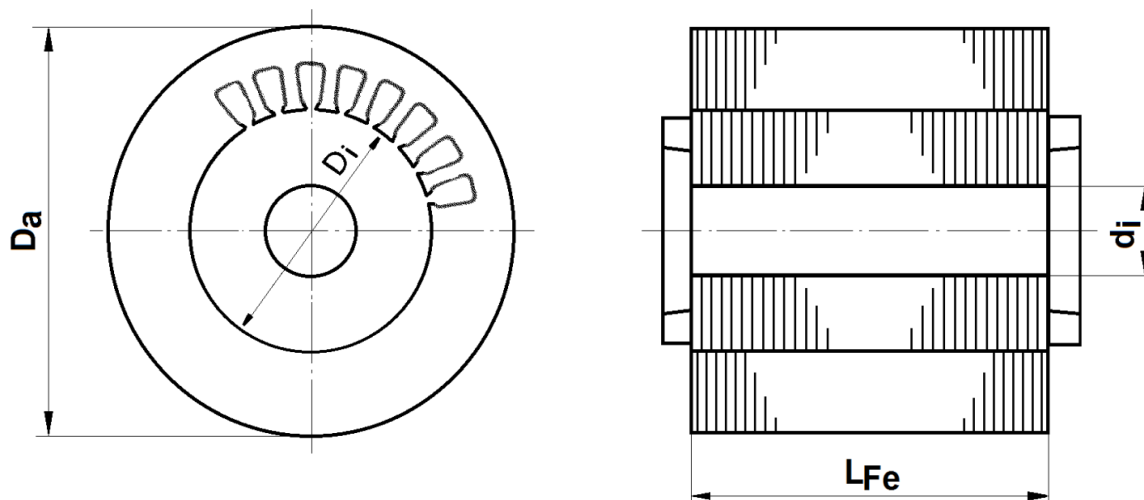

Baugröße Frame size Hauteur d'axe	kW	Abmessungen / Dimensions / Cotes						Artikel-Nr. / Item number / Numero d' article	
		L Fe	Da	DI	di	Nz Stator	Nz Rotor	Stator	Rotor
160M	11	160	240	150	55	36	28	SSA160 4 0160 055	SRA160 4 0160 055
160L	15	215						SSA160 4 0215 055	SRA160 4 0215 055
180M	18,5	200	270	170	65	36	28	SSA180 4 0200 065	SRA180 4 0200 065
180L	22	240						SSA180 4 0240 065	SRA180 4 0240 065
200L	30	250	300	190	75	48	40	SSA200 4 0250 075	SRA200 4 0250 075
225S	37	240	340	215	80	48	40	SSA200 4 0240 080	SRA200 4 0240 080
225M	45	290						SSA225 4 0290 080	SRA225 4 0290 080
250M	55	290	375	240	85	48	40	SSA250 4 0290 085	SRA250 4 0290 085
280S	75	300	420	270	95	48	40	SSA280 4 0300 095	SRA280 4 0300 095
280M	90	360						SSA280 4 0360 095	SRA280 4 0360 095
315S	110	300	500	325	115	60	48	SSA315 4 0300 115	SRA315 4 0300 115
315M	132	370						SSA315 4 0370 115	SRA315 4 0370 115
	160	470						SSA315 4 0470 115	SRA315 4 0470 115
355S	200	370	580	375	130	60	48	SSA355 4 0370 130	SRA355 4 0370 130
	250	450						SSA355 4 0450 130	SRA355 4 0450 130
355L	200	370						SSA355 4 0370 130	SRA355 4 0370 130
	250	450						SSA355 4 0450 130	SRA355 4 0450 130
	315	550						SSA355 4 0550 130	SRA355 4 0550 130